

POWER OUTLET RELOCATOR

Installation Instructions

AS-PWRLODBL

HELIOS™
BY AUDIO SOLUTIONS

KIT CONTENTS:

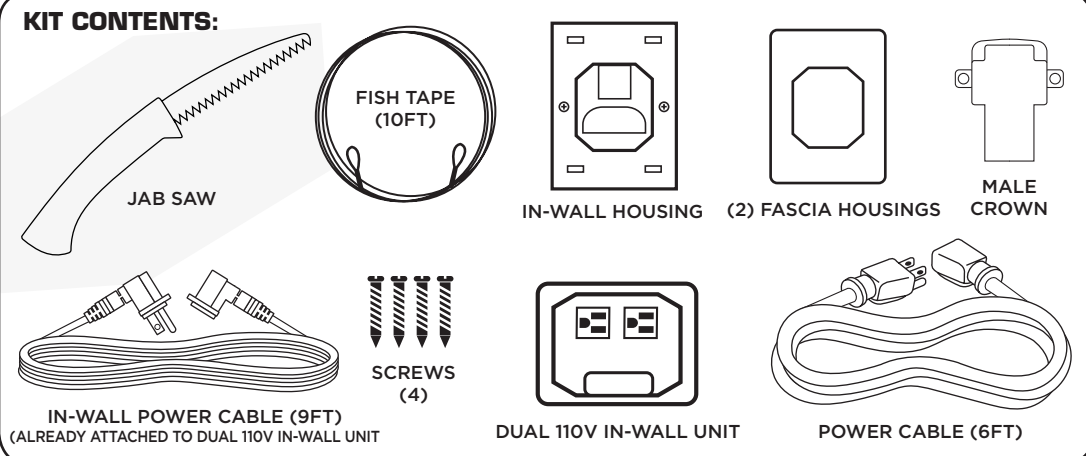

JAB SAW

FISH TAPE (10FT)

IN-WALL HOUSING (2) FASCIA HOUSINGS MALE CROWN

IN-WALL POWER CABLE (9FT)
(ALREADY ATTACHED TO DUAL 110V IN-WALL UNIT)

SCREWS (4)

DUAL 110V IN-WALL UNIT

POWER CABLE (6FT)

TOOLS NEEDED:

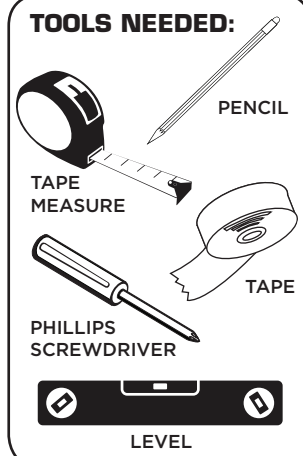

TAPE MEASURE

PENCIL

TAPE

PHILLIPS SCREWDRIVER

LEVEL

1 Check plug size from your TV

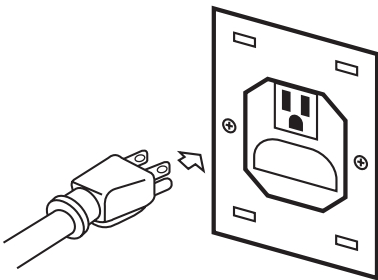

2 Center between studs

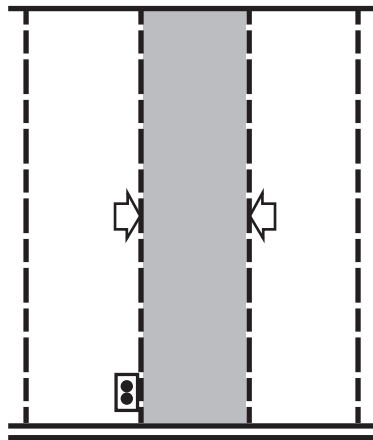

3 Measure and mark the location for holes with pencil

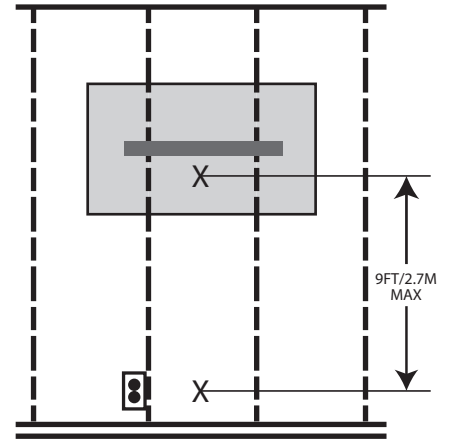

4 Cut holes with provided Jab Saw

Square shape for the upper hole (see back shape of the Dual 110V In-Wall unit)

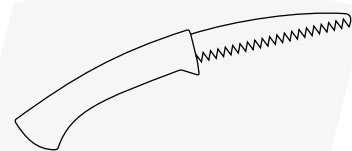

Circular shape for the lower hole (see back shape of the In-Wall Housing unit)

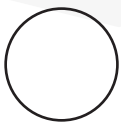

5 Use Fish Tape to snake the Dual 110V In-Wall Unit Power Cable into the wall with the **Male Tip at the bottom**. Use tape to secure the Fish Tape if needed.

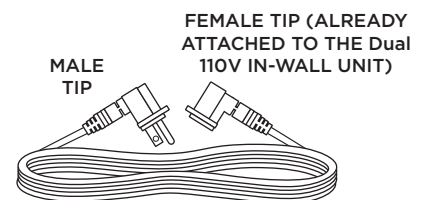
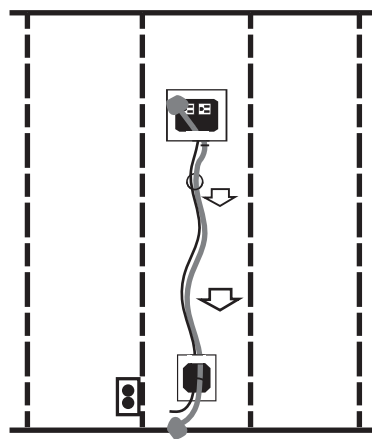

NOTE: Snake any additional AV connection cables at this time. (Coax cable not included)



POWER OUTLET RELOCATOR

Installation Instructions continued

AS-PWRLODBL

HELIOS™
BY AUDIO SOLUTIONS

- 6** At the bottom, insert Male Tip into the back side of the In-Wall Housing unit.

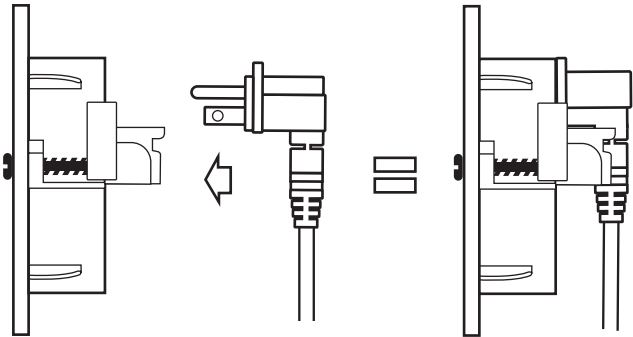

- 7** Snap on Male Crown over the Plug Tip and secure with screws.

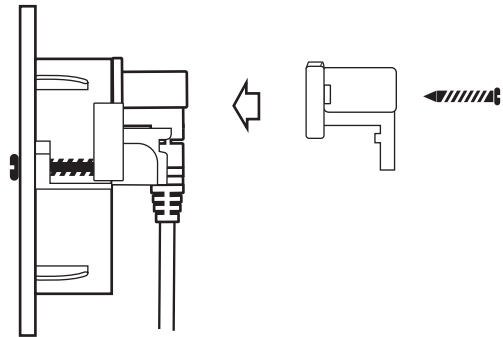

- 8** Fold in Dog Ears and slide Housing into wall. Repeat at the bottom with the Male Housing.

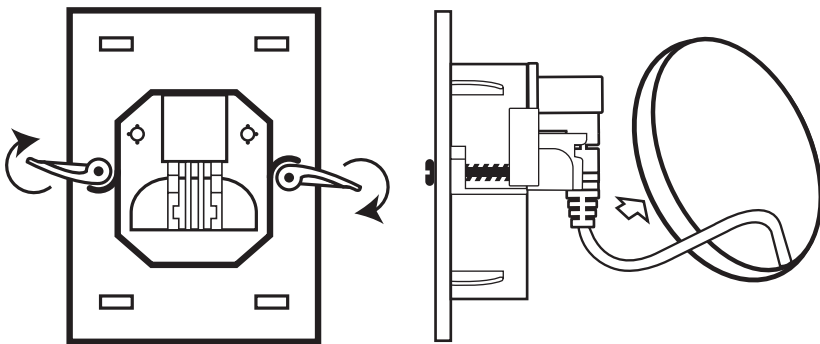

- 9** Level and screw Dog Ears until Housing is secure. Repeat at the bottom with the Male Housing.

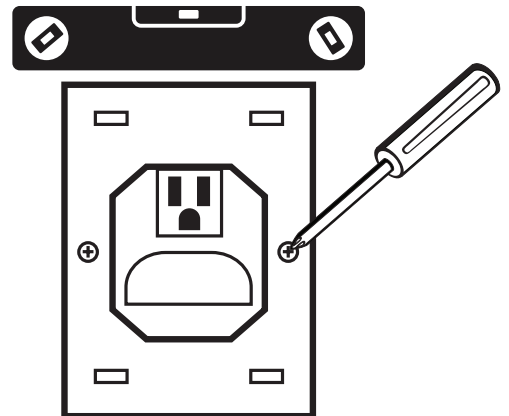

- 10** Snap Housing Fascia onto the front of the Housing. Repeat at the bottom with the Male Housing.

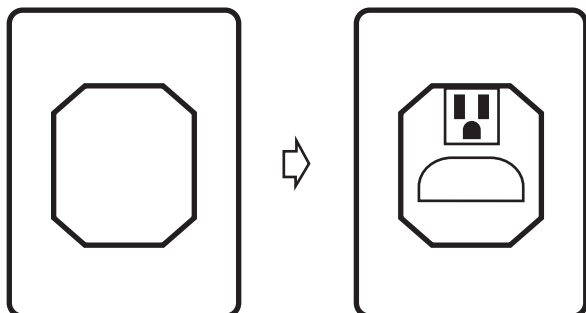

- 11** Plug Extension Cord into the bottom device. Installation is now complete.

